



Little GIANT®

6 SERIES



For residential and light commercial use, the Model 6 Series sump pumps provide efficient and reliable service. For extended or continuous use in moving large volumes of water, these pumps feature a 1-1/2" discharge with a maximum lift of 18', a polycarbonate cover and a polypropylene volute/base. A choice of manual or automatic versions with various switch configurations provides user with the right pump for their needs.

Features

- Cast iron pump housing with protective epoxy coating for corrosion resistance
- Oil-filled motor housing for lifetime lubrication and rapid heat dissipation
- 1/3 HP shaded pole motor
- Stainless steel screws, bolts and handle to protect against corrosion
- Mechanical seal (stainless steel spring, nitrile parts, carbon and ceramic faces) to assure maximum protection against pump failure
- Bearings: Upper and lower sintered sleeve bearings for extended motor life
- Thermal overload protection
- Manual and automatic models
- Automatic operation with pressure switch activates pump when water level is between 7" and 10". Pump shuts off when water level falls to between 1" and 4" (pressure switch is non-adjustable)
- Automatic operation with piggyback mechanical float switch activates pump when water level is between 9" and 10-1/2". Pump shuts off when water level falls to between 2" and 3" (pumping range is adjustable)
-   115 volt models

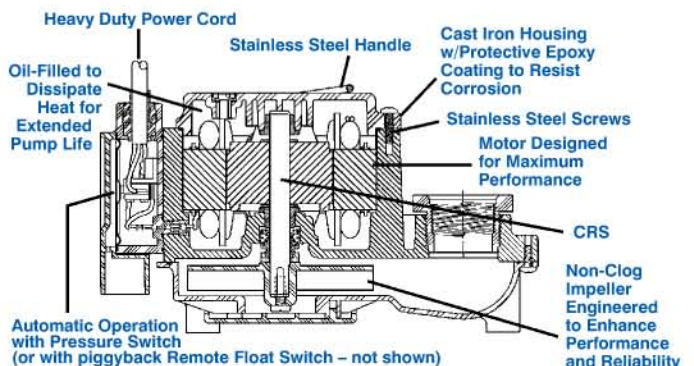

6 SERIES

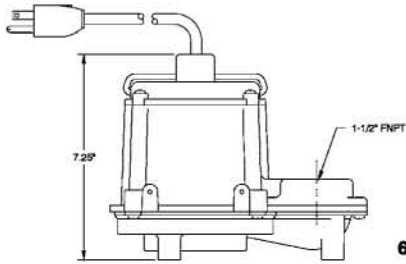

6-CIM-R

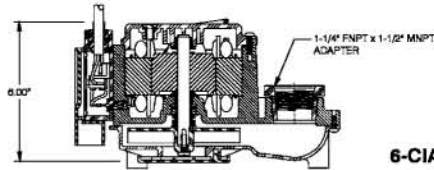
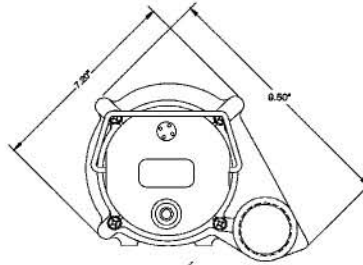

6-CIA

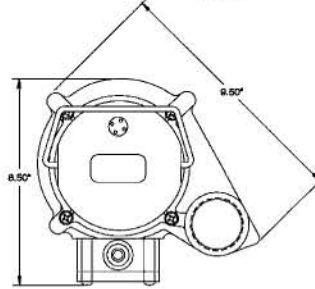

Specifications

Model No.	Item No.	Listing	HP	Volts	Amps		Flow (GPM @ Head)			Shutoff Head (ft.)	P.S.I.	Power Cord (ft.)	Weight (lbs.)	Dimensions (H x L x W) (in.)
					R	Watts	5'	10'	15'					
6-CIM-R	506271	UL/CSA	1/3	115	9.0	720	46	29	12.5	18	7.8	10	16.50	7.25 x 9.50 x 7.25
6-CIM-R	506274	UL/CSA	1/3	115	9.0	720	46	29	12.5	18	7.8	25	18.00	7.25 x 9.50 x 7.25
6-CIA	506125	UL/CSA	1/3	115	9.0	720	46	29	12.5	18	7.8	25	18.50	6.00 x 9.50 x 8.50
6-CIA-RS*	506267	UL/CSA	1/3	115	9.0	720	46	29	12.5	18	7.8	10	17.50	7.25 x 9.50 x 7.25
6-CIM	506266	—	1/3	230	4.5	720	46	29	12.5	18	7.8	12	18.75	6.00 x 9.50 x 8.50
6-CIA	506158	UL/CSA	1/3	115	9.0	720	46	29	12.5	18	7.8	8	18.00	6.00 x 9.50 x 8.50
6-CIA	506168	UL/CSA	1/3	115	9.0	720	46	29	12.5	18	7.8	10	17.75	6.00 x 9.50 x 8.50
6-CIA	506166	—	1/3	230	4.5	720	46	29	12.5	18	7.8	8	18.50	6.00 x 9.50 x 8.50
6-CIA-RFS**	506171	UL/CSA	1/3	115	9.0	720	46	29	12.5	18	7.8	10	17.50	7.25 x 9.50 x 7.25

All models are 60 Hz. CIM – Manual CIA – Automatic

*Manual pump with RS-5 diaphragm switch included to convert to automatic operation.

**Manual pump with piggyback mechanical float switch included for automatic operation.

Continuous Duty Rated — "Little Giant Wastewater pumps are rated continuous duty as long as they are run within the published ratings for these pumps."

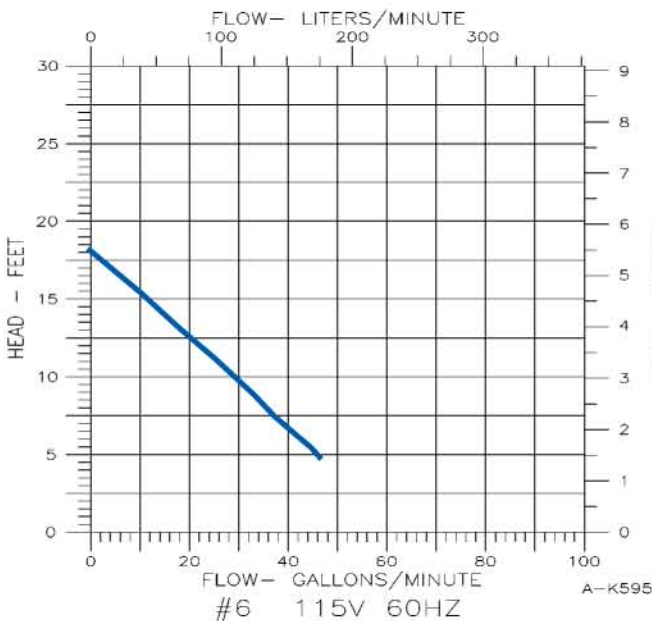

Construction

Cover	Polycarbonate
Motor Housing	Epoxy Coated Cast Iron
Impeller Material	Nylon
Impeller Type	Non-Clog
Volute	Polypropylene
Power Cord	18/3 SJOW-A
Mechanical Shaft Seal	Nitrile w/Carbon & Ceramic Faces
Fasteners	Stainless Steel
Shaft	Cold Rolled Steel
Bearings	Upper: Sintered Iron/Copper, Flanged Sleeve Lower: Sintered Iron/Copper, Flanged Sleeve